

Herkules 2

Microwave motion detector for industrial doors

Translation of the original operation instruction

1 Safety instructions



The unit may only be operated from a protection low-voltage system with electrical separation. The unit may only be opened and repaired by the supplier.

Never touch any electronic components of the detector

2 Description of the detector

Herkules 2
Microwave motion detector
for industrial doors

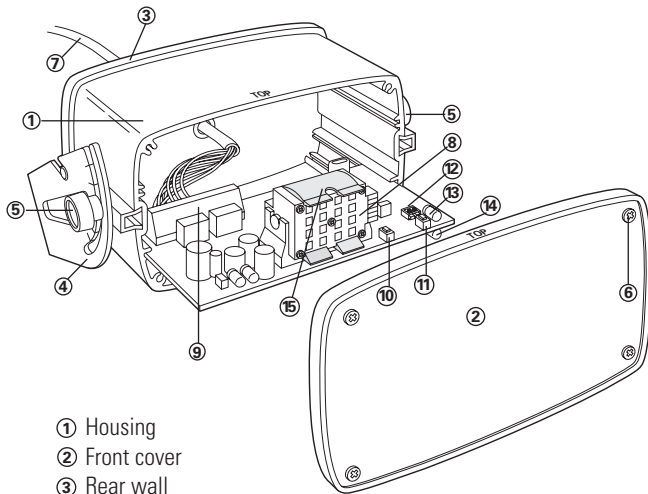

- ① Housing
- ② Front cover
- ③ Rear wall
- ④ Mounting bracket
- ⑤ Fastening
- ⑥ Cover screws
- ⑦ 8-pin cable
- ⑧ Microwave planar module
- ⑨ Screw terminal

- ⑩ Key
- ⑪ Key
- ⑫ Switch addressing
- ⑬ LED red
- ⑭ LED green
- ⑮ Clip

3 Mounting

3.1 Before Mounting



People/Vehicle Identification: Choose whether differentiation between people and vehicles is desired. If so, the minimum mounting height of the sensor is 3 meters!

Field geometry: Select whether a narrow or wide field geometry should be used. The clip must be used for the wide field.

Note: The clip can be used for mounting heights up to max. 4 m. It is not mounted on delivery. (However, it is stuck onto the rear of the antenna.)

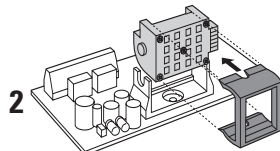
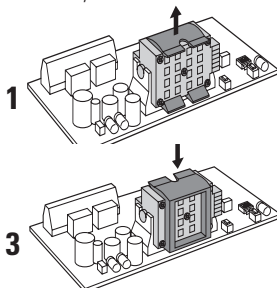

IMPORTANT:
Fit the clip correctly!

- 4 If the device is already connected, interrupt the power supply for 5 seconds.
- 5 After mounting, activate the wide field with the remote control (B+1).

Addressing: Each detector can be assigned an address (1–4 with DIP switch and 5–7 with remote control). Different addresses are necessary when several detectors are within the range of a remote control.

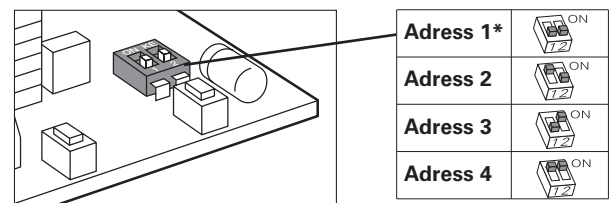

* Factory setting

Other addresses 5, 6 + 7 can be set using the remote control (F+8+5...7)

3.2 Mechanical mounting



- The detector must be firmly mounted on a flat surface. (Avoid vibrations)
- Objects such as plants, flags, fans etc. must not protrude into the detection area.
- The detector must not be obscured by covers/signs
- Fluorescent lamps should not be placed in the immediate vicinity of the detection area
- Mount the device in the middle above the industrial door

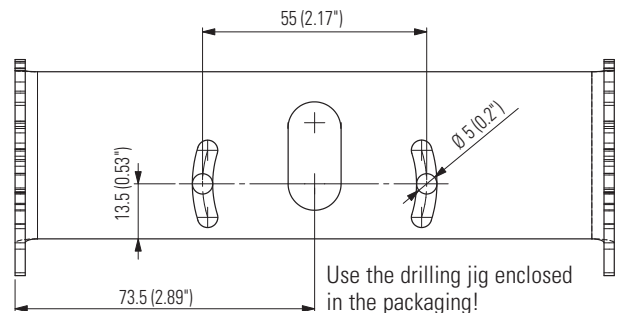

1. Affix drilling jig to wall or ceiling and drill holes according to values given.
2. Route cable through opening provided in mounting bracket and make sure length is sufficient for wiring.
3. Screw mounting bracket on tightly
4. Hook detector into mounting bracket and set detector to required angle. Standard angle: 30°
5. Connect cable according to type plate.

Wall mounting:

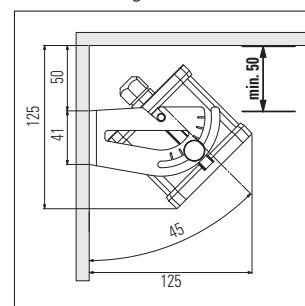

Ceiling mounting:

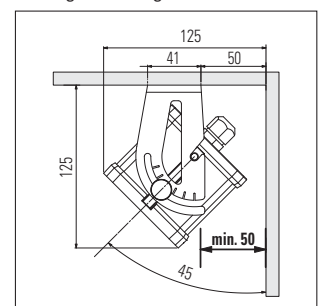

3.3 Electrical connections

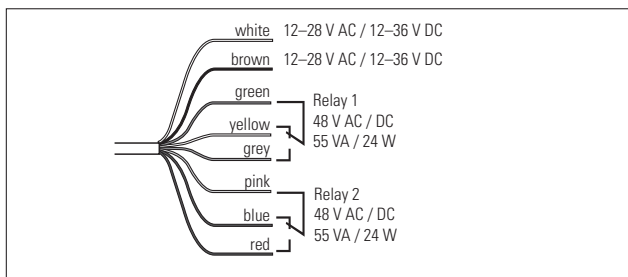

4 Settings

4.1 Switching on and factory setting

After the supply voltage has been connected, the red LED signals "Start-up" by flashing.

The factory setting is suitable for the following applications:

- Mounting height 4.0 to 4.9 m
- Relay hold interval 2 s
- Slow motion detection switched off
- Differentiation between people and vehicles active
- Crossing traffic optimisation switched off
- Detection of movements towards the detector (forwards)

The factory settings can be restored at any time using the remote control (A+9)!

4.2 Establishing the connection to the remote control

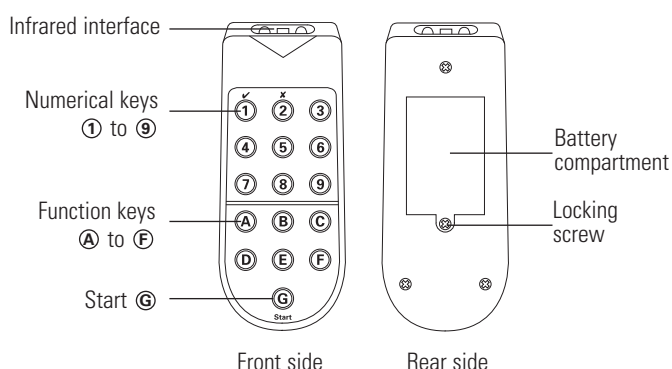

Press key **G** on the remote control. If the connection has been established successfully, **G** and one of the keys **1 to 7** light up (address of the detector).

If **G** flashes, the connection could not be established.

- Hold the remote control closer to the detector and point directly at it.
- Check the batteries in the remote control.

General:

Flashing keys on the remote control mean that the Herkules 2 has not stored the programming that has been performed.

Steady lit keys on the remote control mean that the value has been accepted and stored by Herkules 2.

4.3 Configuration mode

The connection between the remote control and Herkules can only be established when the detector is in configuration mode. Configuration mode is activated when the detector is switched on. This is deactivated automatically 30 minutes after the last setting has been made.

Configuration mode can be activated by:

- Pressing any key on detector (x or y)
- Interrupting electrical power supply
- Via access code on remote control

Configuration mode can only be activated with the remote control if a code has been stored previously (see access code).

1. Press start key **G**
→ **G** and one of the keys **1...7** light up
2. Press **C** then **9**
→ **C** and **1** light up
→ Access code function is switched on
3. Enter four-digit code 1111 - 9998
4. Press **C**
→ **C** and **1** light up
→ Configuration mode is activated
→ Detector is ready for programming
→ If **C** and **2** light up, code was incorrect
→ Start again from step 1

4.4 Most important settings

1. Select enhanced level (**C+1...8**)
2. Set mounting height (**F+4+1...7**) if different from factory setting

Important: The detector will not function correctly if the wrong mounting height is set



3. Set field size (**D+1...9**) if necessary using inclination angle, 0–90°, in 15° steps

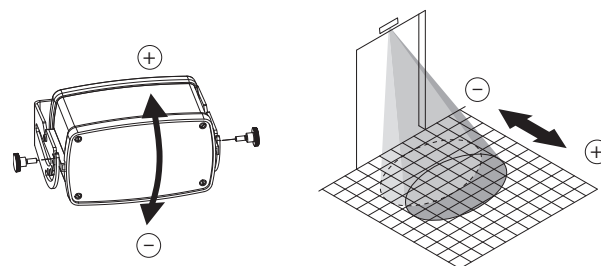

4.5 Displays on the detector

Start-up phase

Red LED	Flashes several times during start-up, first slowly then quickly.
---------	---

Configuration

Green LED	Indicates the parameter (function no.) by the frequency of flashing.
Red LED	Indicates the parameter level by the frequency of flashing.

Operation

Green LED	Lights up on detection, relay 2 is activated.
Green LED	Flashes on detection in the SMD field.
Red LED	Lights up on detection, relay 1 is activated.

Explanations

SMD = Slow Motion Detection

The slightest (quasi-static) movements are detected as soon as the industrial door opens. The industrial door is only closed if no more movement is registered during the set monitoring time.

CTM = Crossing traffic masking

Crossing traffic masking prevents an industrial door from being inadvertently opened by objects that are only moving or walking past it but do not want to pass through.

P/V identification

Using this function, it is possible to select whether the relay outputs should be switched separately in response to people or vehicles (see table of relay parameter settings).





















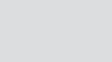

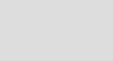
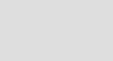

4.6 Overview of settings

Enhanced functions (refer to chapter 5.9)

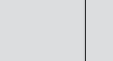
Keys	C+1 Standard	C+2 Frontal	C+3 High-speed	C+4 Sensitive	C+5* Standard	C+6 Frontal	C+7 High-speed	C+8 Sensitive
Object detection	All				Person/vehicle identification, people suppression			
Industrial door type	Standard	Standard	High-speed industrial door	Standard	Standard	Standard	High-speed industrial door	Standard
Application	Standard	Main traffic frontal	High-speed industrial door	Detects slow objects	Standard	Main traffic front	High-speed industrial door	Detects slow objects
B: Wide field	Level 2 Off	Level 2 Off	Level 2 Off	Level 2 Off	Level 2 Off	Level 2 Off	Level 2 Off	Level 2 Off
D: Field size	Level 6	Level 6	Level 6	Level 8	Level 6	Level 6	Level 6	Level 8
E+1: Direction recognition	Level 1 forwards	Level 1 forwards	Level 1 forwards	Level 1 forwards	Level 1 forwards	Level 1 forwards	Level 1 forwards	Level 1 forwards
E+2: Relay parameterisation	Level 5 R2: forwards R1: backwards	Level 5 R2: forwards R1: backwards	Level 8 R2: forwards R1: backwards	Level 5 R2: forwards R1: backwards	Level 1 R2: Vehicle R1: Person	Level 1 R2: Vehicle R1: Person	Level 6 R2: Vehicle R1: —	Level 1 R2: Vehicle R1: Person
F1: Relay hold interval	Level 4 2 s	Level 4 2 s	Level 4 2 s	Level 4 2 s	Level 4 2 s	Level 4 2 s	Level 4 2 s	Level 4 2 s
F3: SMD	Level 1 Off	Level 2 Weak	Level 1 Off	Level 8 Strong	Level 1 Off	Level 2 Weak	Level 1 Off	Level 8 Strong
F5: Cross traffic	Level 1 Off	Level 6 Medium	Level 1 Off	Level 2 Weak	Level 1 Off	Level 6 Medium	Level 1 Off	Level 2 Weak
F6: Digital filter function	Level 2 Off	Level 2 Off	Level 2 Off	Level 2 Off	Level 2 Off	Level 2 Off	Level 2 Off	Level 2 Off
F7: SMD-field	Level 1 Small	Level 5 Medium	Level 1 Small	Level 5 Medium	Level 1 Small	Level 5 Medium	Level 1 Small	Level 5 Medium
F8: Adress	From DIP Switch	From DIP Switch	From DIP Switch	From DIP Switch	From DIP Switch	From DIP Switch	From DIP Switch	From DIP Switch

*factory settings

Relay parameter settings (refer to chapter 5.13)

E+2	1	2	3	4	5	6	7	8	
Application	Standard					High-speed industrial door			
Relay 2 (Green LED)	 			   	  		 	 	 
Relay 1 (Red LED)	 				 			 	
									



Switches in response to vehicle



Switches in response to person



Switches in direction detection (E+1+1)



Switches in direction detection (E+1+1 or E+1+2)

Configuration of individual parameters with «RegloBeam 2» remote control

Parameter	Key code	Level	Short description	
Request access code	C+9	Display 1 Display 2	Code saved No Code	
Set Code Enter Code Delete Code	C+9	XXXX+C XXXX+C 9999+C	Number from 1111–9998 and confirm with C Enter selected code and confirm with C Code deleted	
Address settings	F+8		interrogate target address	
		5–7	setting address 5–7	
		9	read in address from DIP-Switch	
Enhanced function	C	1–8	See table of enhanced functions	
Mounting height	F+4	1	2.0 – 2.4 m	
		2	2.5 – 2.9 m	
		3	3.0 – 3.9 m	
		4*	4.0 – 4.9 m	
		5	5.0 – 5.9 m	
		6	6.0 – 6.9 m	
		7	7.0 m	
Field size	D	1–3	Small	
		4–6*	Medium	
		7–9	Large	
Relay hold interval	F+1	1	0.2 s	
		2	0.5 s	
		3	1.0 s	
		4*	2.0 s	
		5	5.0 s	
Direction recognition	E+1	1*	Forwards	
		2	Backwards	
		3	Forwards and backwards	
Relay parameterisation	E+2	1*	Standard industrial door, differentiation between people and vehicles	
		2	Standard industrial door, people suppression	
		3	Standard industrial door, vehicle suppression	
		4	Standard industrial door, people and vehicles, same output	
		5	Standard industrial door, people and vehicles, outputs with direction segregation	
		6	High-speed industrial door, people suppression	
		7	High-speed industrial door, people and vehicles, same output	
		8	High-speed industrial door, people and vehicles, outputs with direction segregation	
CTM Crossing traffic masking	F+5	1*	Off	
		2–3	Low	
		4–6	Medium	
		7–9	High	
Wide field	B	1	On	
		2*	Off	
Slow Motion Detection	F+3	1*	Off	Decreasing sensitivity
		2	0.5 s	
		3	1.0 s	
		4	1.5 s	
		5	2.0 s	Constant sensitivity
		6	0.5 s	
		7	1.0 s	
		8	1.5 s	
		9	2.0 s	
SMD field size	F+7	1*–3	Small	
		4–6	Medium	
		7–9	Large	
Digital filter function	F+6	1	On	Avoidance of false tripping by fluorescent tubes
		2*	Off	
Manual industrial door opening	A	1	Switch off both relays	
		2	Switch on relay 1	
		3	Switch on relay 2	
Exit configuration mode	A	4		
Reset	A	9	Reinitialise	



People/Vehicle Identification: Choose whether differentiation between people and vehicles is desired. If so, the minimum mounting height of the sensor is 3 meters!

* Factory setting

5 Explanation of functions and settings

5.1 General description of the remote control

The RegloBeam 2 remote control allows you to program Herkules 2 easily and conveniently from the ground. Data transfer between RegloBeam 2 and Herkules 2 functions in both directions, i.e. to and from the detector, and is guaranteed by an infrared interface. The RegloBeam 2 reads back the adjusted values immediately after programming and displays them for control purposes. This ensures safe and correct programming.

5.2 Function of the «RegloBeam 2» remote control

The «RegloBeam 2» remote control functions using a combination of functions and number keys. Take care to operate it correctly as described in chapter 4.2.

Flashing keys on the RegloBeam 2 indicate that the data has not been fully transmitted. Avoid exposing the infrared interface to direct sunlight or other light sources.

5.3 Layout of the «RegloBeam 2» remote control

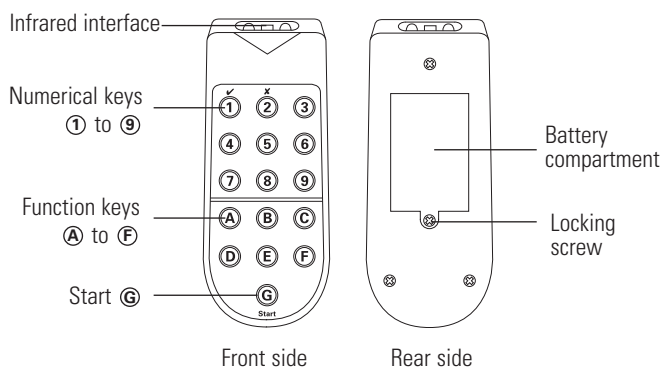

5.4 Configuration mode

The connection between the RegloBeam 2 and Herkules 2 can only be established when the detector is in configuration mode. Configuration mode is activated when the detector is switched on. For safety reasons, this mode is automatically deactivated 30 minutes after the last setting has been made on the detector. Configuration mode can be exited at any time by pressing keys A+4.

Configuration mode can be activated in three different ways:

- a) By pressing any key X or Y key on the detector

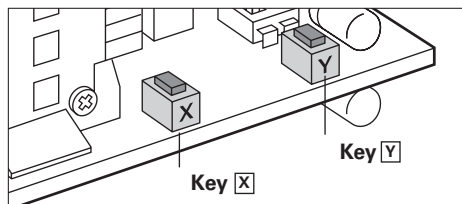

- b) By restarting the detector (disconnecting the supply voltage)

- c) Access via remote control with access code

5.5 Establishing the connection

Press start key G on the RegloBeam 2

- If the connection has been established successfully, G and one of the keys 1 to 7 light up (address of the detector)
- If G flashes, the connection could not be established
- Hold the remote control closer to the detector and point directly at it
- Check the batteries of the RegloBeam 2.
- Replace the batteries if nothing lights up.
- Configuration mode is not activated if G and one of the keys 1 to 7 light up although no further settings are possible.

Please refer to the first part (4.6) for an overview of individual parameters and the enhanced level settings.

Note: Programming must be carried out within 30 s. If this time elapses, it is necessary to activate programming mode again (press key G

5.6 Configuration with keys

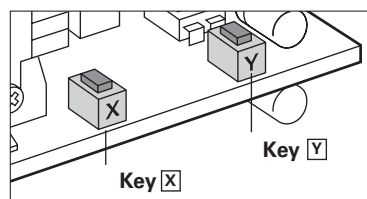

Procedure

Press keys X and Y at the same time to access the required mode.

Primary mode:

Press keys X and Y simultaneously and hold for 2 s
→ Green LED lights up, then release

Secondary mode:

Press keys X and Y simultaneously and hold for 4 s
→ Red LED lights up, then release

Reset:

Press keys X and Y simultaneously and hold for 8 s
→ Both LED lights up, then release

Mode	Parameter (key X)	Function no.	Level key Y
Primary	Enhanced level	1	1-8
	Mounting height	2	1-7
	Relay parameter setting	3	1-8
	Field size	4	1-9
Secondary	Relay hold interval	1	1-5
	Direction recognition	2	1-3
	Crossing traffic masking	3	1-9
	Wide field	4	1-2
	SMD level	5	1-9
	SMD field size	6	1-9
	Digital filter function	7	1-2

Changing the function

Press key X. The value increases by 1 for every key press (function no.). Once the last function has been reached, the program jumps back to the first function. The green LED then indicates the number of the activated function.

Changing the level

Press key Y. The value increases by 1 for every key press (level). Once the last level has been reached, the program jumps back to the first level.

Exiting programming mode

Exit programming mode by pressing both keys X and Y briefly at the same time.

5.7 Adjusting the detector

The settings are identified as follows:

- e.g. **D+...** Remote control menu
 e.g. **P.1...** Primary programming mode with keys, function no. 1
 e.g. **S.3...** Secondary programming mode with keys, function no. 3

5.8 Mounting height F+4

F + 4 + 1...7 P2+1...7 (keys)

- 1 = 2.0 bis 2.4 m 5 = 5.0 bis 5.9 m
 2 = 2.5 bis 2.9 m 6 = 6.0 bis 6.9 m
 3 = 3.0 bis 3.9 m 7 = 7.0 bis 7.9 m
 4 = 4.0 bis 4.9 m

It is essential to adjust the mounting height if it does not match the factory setting.

5.9 Comfort functions C

These pre-programmed settings allow you to configure the system quickly and easily for standard applications.

Remote control	Function	Keys
C + 1	Standard, detects all objects	P.1+1
C + 2	Frontal traffic, all objects	P.1+2
C + 3	High-speed industrial door, all objects	P.1+3
C + 4	Detects slow movements, all objects	P.1+4
C + 5	Standard, differentiation between people and vehicles	P.1+5
C + 6	Frontal traffic, differentiation between people and vehicles	P.1+6
C + 7	High-speed industrial door, people suppression	P.1+7
C + 8	Detects slow movements, differentiation between people and vehicles	P.1+8

Note: The selected enhanced function is only read back and displayed as such if no parameters were changed. Please refer to the table of enhanced functions in 4.6 for more details.

5.10 Field size D

D + 1...9 P.4+1...9 (keys)

Levels 1 (small field) to 9 (large field)
 Refer to the technical data for field dimensions.

5.11 Relay hold interval F+1

F + 1 + 1...4 S.1 + 1...5 (keys)

- 1 = 0.2 s
 2 = 0.5 s
 3 = 1.0 s
 4 = 2.0 s
 5 = 5.0 s

The relay hold interval only starts after other functions have been completed (delayed).

5.12 Direction recognition E+1

Remote control	Function	Keys
E+1+1	Forwards, movement towards detector	S.2+1
E+1+2	Backwards, movement away from detector	S.2+2
E+1+3	Forwards and backwards	S.2+3

5.13 Relay parameter settings E+2

Remote control	Function	Keys
E+2+1	Standard industrial door, differentiation between people and vehicles	P.3+1
E+2+2	Standard industrial door, people suppression	P.3+2
E+2+3	Standard industrial door, vehicle suppression	P.3+3
E+2+4	Standard industrial door, people and vehicles, same output (relay 2)	P.3+4
E+2+5	Standard industrial door, people and vehicles, outputs with direction segregation	P.3+5
E+2+6	High-speed industrial door, people suppression (relay 2)	P.3+6
E+2+7	High-speed industrial door, people and vehicles, same output (relay 2)	P.3+7
E+2+8	High-speed industrial door, people and vehicles, outputs with direction segregation	P.3+8

Please also refer to the table of relay parameter settings in point 4.6!

5.14 Crossing traffic masking CTM F + 5

CTM prevents an industrial door from being inadvertently opened by vehicles or persons that are only moving or walking past it but do not want to pass through the industrial door.

F + 5 + 1 = Aus **S.3 + 1**
F + 5 + 2...9 **S.3 + 2...9**

Industrial door remains closed to crossing traffic (level 9)

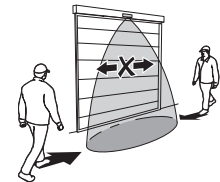

Industrial door opens to crossing traffic or when an object approaches laterally (level 1)



Optimum inclination angle for crossing traffic function: 30° to 45°

Crossing traffic masking is not possible with the clip!

5.15 Wide field B

B + 1 = On **S.4 + 1**
B + 2 = Off **S.4 + 2**

Field without clip

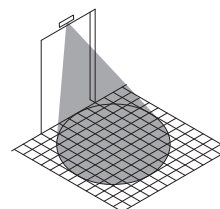

Field with clip

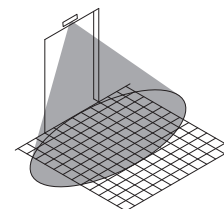

This option must be activated when the mechanical clip is used for setting a wide field. Please refer to 3.1 for information about clip mounting.



The detector will not function correctly if the wrong setting is made.

5.16 Slow Motion Detection (SMD) F+3

The slightest (quasi-static) movements are detected as soon as the detector is activated. The detector only issues the corresponding signal to the industrial door controller if no more movement is registered during the set monitoring period. Sensitivity during this monitoring period can be set to decrease or remain constant.

Remote Control	Function	Keys
F+3+1	Off	S.5+1
F+3+2...5	Decreasing sensitivity	S.5+2... 5
F+3+6...9	Constant sensitivity	S.5+6... 9



5.17 Special settings

Manual industrial door opening

- A + 1 = Both relays off
- A + 2 = Relay 1 on
- A + 3 = Relay 2 on
- A + 4 = Both relays off, exit configuration mode

Reset A+9

This function resets all device parameters to the factory settings (see 4.1) and a new initialisation phase starts as if the device had been switched on again.

The reset also deletes the access code. There are two possible ways of resetting the device to its factory settings:

- 1) With the remote control
 - A + 9 = Reset
- 2) With the keys:
 - Press keys X and Y simultaneously and hold for 8 seconds.
 - Every 2 seconds, both LEDs light up briefly. Both LEDs light up after 8 seconds. The reset is performed when the keys are released.

Access code

Herkules 2 can be protected against unwanted manipulation by means of a four-digit access code. This code enables configuration mode to be reactivated at any time by remote control in order to perform settings. This function is inactive by default.

Switching on access code:

The code can only be stored if the detector is already in configuration mode. The device is protected as soon as the code has been stored. (Configuration mode is deactivated)

1. Press start key **G**
 - **G** and one of keys 1...7 light up
2. Press **C** then **9**
 - C and 2 light up
 - The access code function is switched off (no code stored)
3. Enter the 4-digit code (any number between **1111 – 9998**)
4. Press **C**
 - **C + 1** lights up
 - The access code function is switched on (code stored)
 - Configuration mode is deactivated (device is protected).

Switching off access code:

The code can only be deleted if the detector is already in configuration mode.

1. Press start key **G**
 - **G** and one of keys 1...7 light up
2. Press **C** then **9**
 - **C + 1** light up
 - Access code function is switched on
3. Press **9** four times, then press **C**
 - **C** and **2** light up
 - The access code function is switched off (code deleted)

Activating configuration mode

The connection between the remote control and Herkules 2 can only be established when the detector is in configuration mode.

Configuration mode is activated when the detector is switched on. This is deactivated automatically 30 minutes after the last setting has been made.

Configuration mode can be activated by:

- Pressing any key on detector (x or y)
- Interrupting electrical power supply
- Via access code on remote control

Configuration mode can only be activated with the remote control if a code has been stored previously (see access code)

1. Press start key **G**
 - **G** and one of keys 1...7 light up
2. Press **C** then **9**
 - **C** and **1** light up
 - Access code function is switched on
3. Enter four-digit code 1111 – 9998
4. Press **C**
 - **C** and **1** light up
 - Configuration mode is activated
 - Detector is ready for programming
 - If **C** and **2** light up, code was incorrect
 - Start again from step 1

Switching off access code function (deleting code) without remote control

Press both keys X and Y simultaneously and hold for 8 seconds. Both LEDs light up briefly every 2 s.

- Device is reset to factory settings
- Access code function is switched off
- (Code deleted)
- New initialisation and teach-in phase starts (see 4.1)

Digital filter function

In special mounting situations, it might be necessary to activate the filter function under certain circumstances. Sources of interference located close to the detector can lead to malfunctions.

- F + 6 + 1 = On S.7 + 1
- F + 6 + 2 = Off S.7 + 2

Addressing Herkules 2

Seven different addresses for communication with the RegloBeam 2 remote control can be set on the Herkules 2. Addresses 1 – 4 are set using the built-in DIP switch.

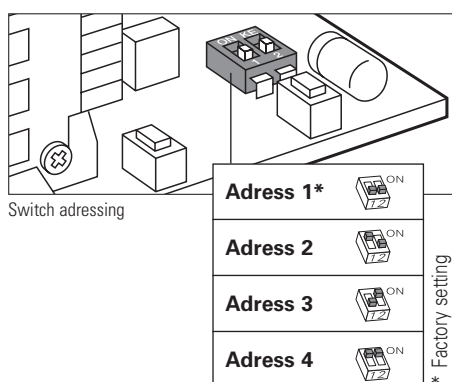

Addresses 5 – 7 are set using the remote control.

- F + 8 + 5 = Address 5
- F + 8 + 6 = Address 6
- F + 8 + 7 = Address 7
- F + 8 + 9 = Read in set address from DIP switch

Different addresses should be set if detectors are mounted next to or opposite to one another and are within range of the same remote control.

6 Troubleshooting

Symptom	Possible cause	Remedy	Refer to chapter
Industrial door reverses	Detector detects industrial door	Change the inclination angle of the microwave module	4.4
Industrial door opens – false tripping	Interference source affects microwave field (e.g. fluorescent tubes)	Activate the interference suppression filter (F6+1)	5.17
Late detection or non-detection of persons	Field is too small, incorrect mounting height set	Check the field size (D1...9). Set the correct mounting height (F4+1...7). Check setting for wide field.	5.10 5.8 5.15
P/V identification does not function	Incorrect mounting height entered	Set the correct mounting height (F4+1...7). Check setting for wide field.	5.8 5.15

7 Technical data

Technology	Doppler radar with planar module
Transmitting frequency	24.05–24.25 GHz
Transmitting power	< 20 dBm
Operating voltage	12–28 VAC, 12–36 VDC
Operating current	max 75 mA
Mains frequency	50 Hz
Temperature range	–30° bis 60° C
Air humidity	0% to 95% relative, without condensation
Mounting height	2.0 bis 7 m
Relay outputs	Potential-free changeover contacts
Switching voltage	max 48 VAC/DC
Switching current	max 0.5 A AC

Housing	Aluminium black anodized, Cover Polycarbonat
Dimensions	134 x 82 x 75 mm
Weight	720 g incl. cable
Protection class (EN 60529)	IP 65
Max. detection speed	25 km/h for vehicles
Cabel	Length 5 m, 8 x 0.14 mm ²
Suitable for the following countries	EU, EFTA, US, CA
Field dimensions with 30° inclination	from 2.5 m x 3 m (WxD) height 2 m to 5 m x 7 m (WxD) height 7 m

8 EU Declaration of Conformity

 See attachment

9 WEEE



Devices with this symbol must be treated separately during disposal. This must be done in accordance with the laws of the respective countries for environmentally sound disposal, processing and recycling of electrical and electronic equipment.

10 FCC approval



This device meets the requirements of Part 15 of the FCC regulations and the RSS-210 standard of Industry Canada.
Warning: Changes or modifications made to this device may void the FCC authorisation to operate this device.

11 Contact

BBC Bircher Smart Access, BBC Bircher AG, Wiesengasse 20, CH-8222 Beringen, www.bircher.com
Designed in Switzerland / Made in China