

D1-Series, DW40

Pressure Wave Switch

for pneumatic wave profiles

The pressure wave system stands out thanks to its high level of response sensitivity, which enables it to protect people and vehicles from practically all directions. Due to their robustness and durability, these switches are also really impressive when used as opening sensors for automatic gates and vehicle doors on buses and trains.

Just a slight pressure of 3 to 4 mbar on the sensor is all that is needed to guarantee reliable switching. Pressure-wave switch systems have highest requirements to failure safety, are absolute reliable and maintenance-free, plus they offers a particularly favourable price-performance ratio.

Material data Overview

Housing	PBT GF30
Metal parts	CuZn, Ni plated
Metal spring parts	Stainless Steel
Sealing	EPDM
Membrane	Silicone
Bush	POM
Switch contacts	AgNi







Technical data

Dimensions in mm	49 x 41 x 34.5
Response pressure	min. 2 mbar / max. 150 mbar
Pressure equalisation	100 ml / min (@ 2 mbar)
Min./max. current	20 mA / 500 mA (ACDC ohmic)
Min./max. operating voltage	24 - 250 VAC, 24 - 50 VDC
Output	NC or NO
Mechanical service life	50 million switches
Ambient temperature	-30°C to + 70°C

Conformity

REACH compliance	published on www.bircher.com
RoHS compliance	published on www.bircher.com

Options for DW40, p/n

210018	DW40	standard	Pressure closes contact	
210019	DW40AMP	option	Pressure closes contact, for AMP connectors	
210025	DW40DOE	option	Pressure opens contact	
210095	DWGK1	option	Screw-on housing incl. of pressure wave switch	
210111	DWGK1DOE	option	Screw-on housing incl. of pressure wave switch pressure opens contact	
210096	DWGK11	option	Snap-in housing incl. of pressure wave switch	
210097	DWGK11DOE	option	Snap-in housing incl. of pressure wave switch pressure opens contact	



Dimensions

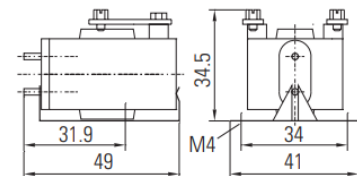

Functional principles

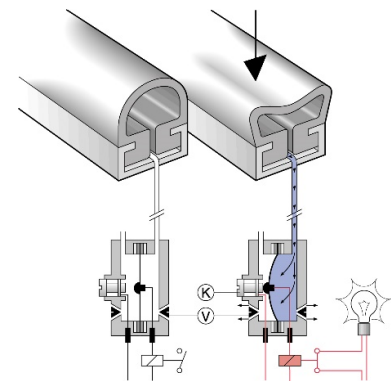

Housing

